

RevNo	Revision note	Date	Sign.	Checked
-------	---------------	------	-------	---------

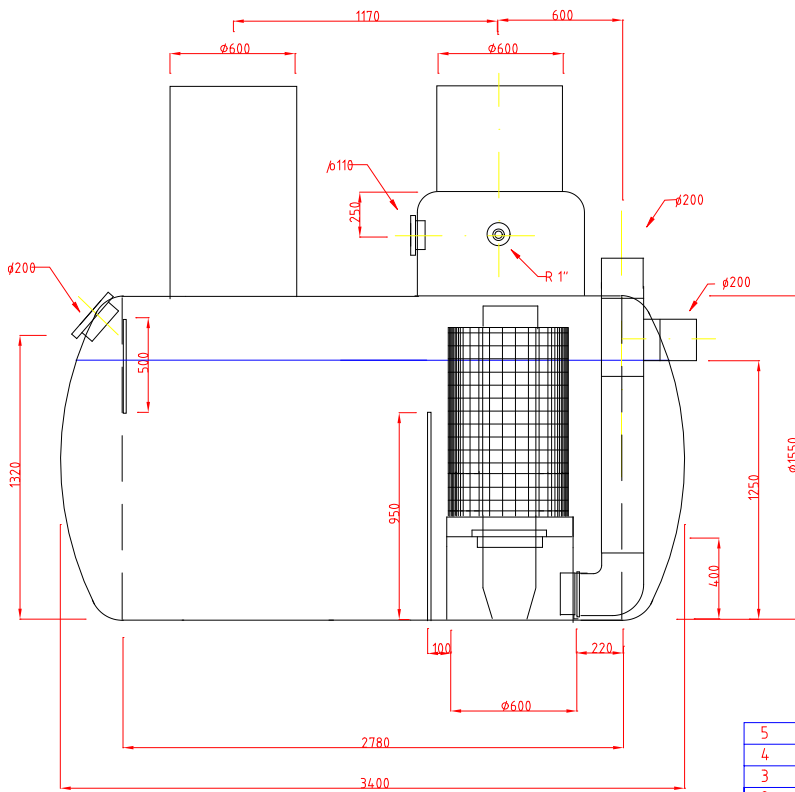

5			
4			
3			
2			
1			

Pos.nr	Antal	Beskrivning / Mtrl / Dimension mm	Anmärkning
Design by Peter Björklund	Checked by	Approved by / date	Filename Date 2006-05-17

bia	HÄRDPLAST AB Örrtorp 731 90 KÖPING Tel. +46 (0)221 211 30 Fax +46 (0)221 125 09	Oljeavskiljare typ Coalecens CAM 15 S	Edition Sheet 1/1
------------	---	--	-------------------------