

SECTION A-A

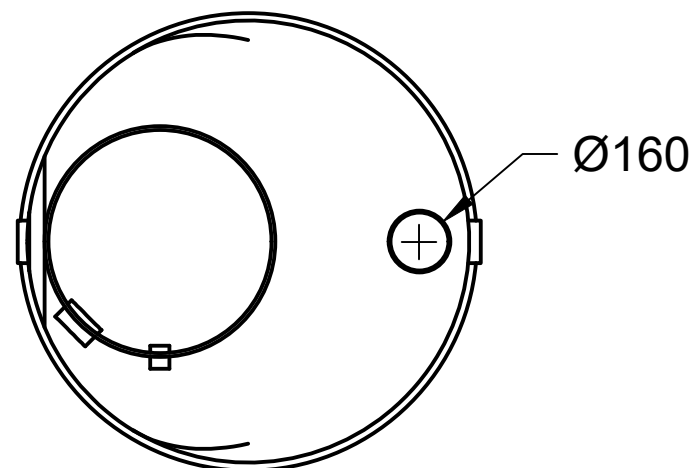

Pos.nr	Antal	Beskrivning / Dimension mm	Anmärkning		
Design by Mathias Toresson	Checked by	Approved by / date	Filename FAMS 2 200L	Date 2020-06-22	Scale 1:500
bia		HÄRDPLAST AB Orrtorp 731 98 KÖPING Tel. +46 (0)221 211 30 Fax +46 (0)221 125 09	Stående fettavskiljare		
Typ FAMS 2 200L			Edition	Sheet 1/1	